

5 cm

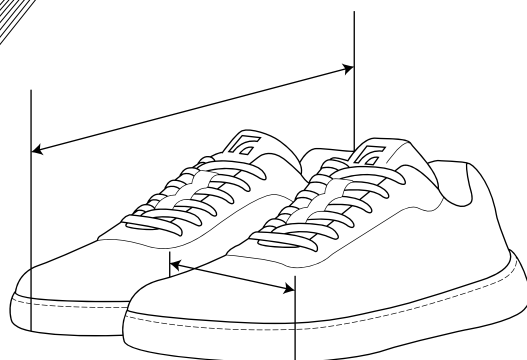

EU	A (cm)	B (cm)
36	8,8	23,3
37	9,0	23,9
38	9,2	24,6
39	9,4	25,3
40	9,6	25,9
41	9,8	26,6
42	10,0	27,3
43	10,2	27,9
44	10,3	28,6
45	10,5	29,3
46	10,7	29,9
47	10,9	30,6

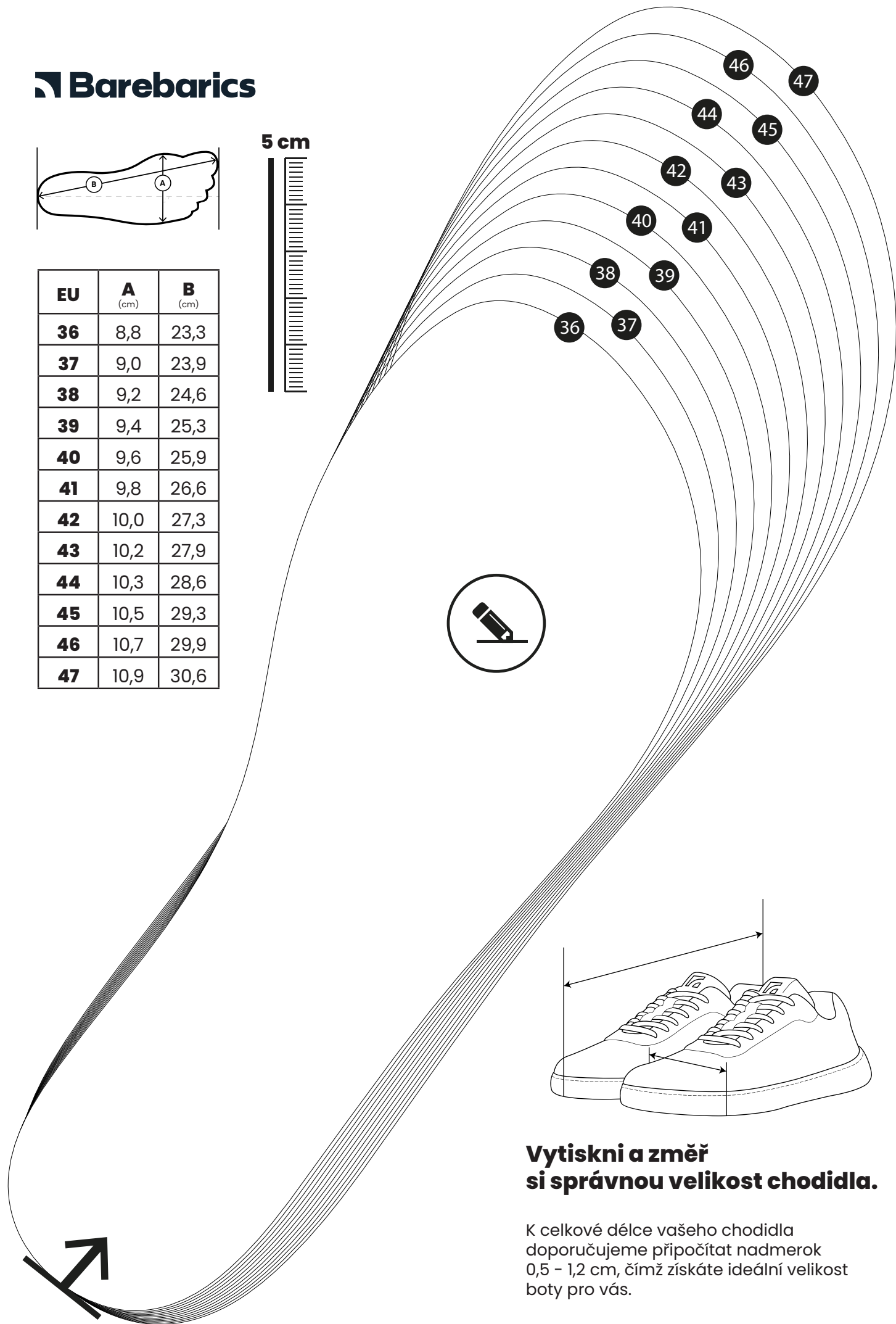

Vytiskni a změř si správnou velikost chodidla.

K celkové délce vašeho chodidla doporučujeme připočítat nadměrok 0,5 - 1,2 cm, čímž získáte ideální velikost boty pro vás.

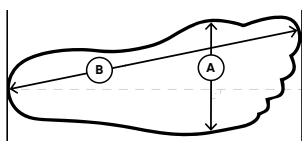

5 cm



EU	A (cm)	B (cm)
36	8,8	23,3
37	9,0	23,9
38	9,2	24,6
39	9,4	25,3
40	9,6	25,9
41	9,8	26,6
42	10,0	27,3
43	10,2	27,9
44	10,3	28,6
45	10,5	29,3
46	10,7	29,9
47	10,9	30,6

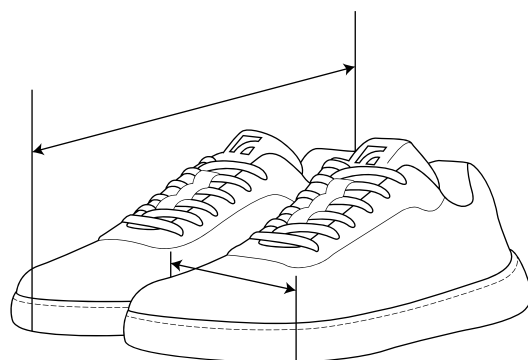
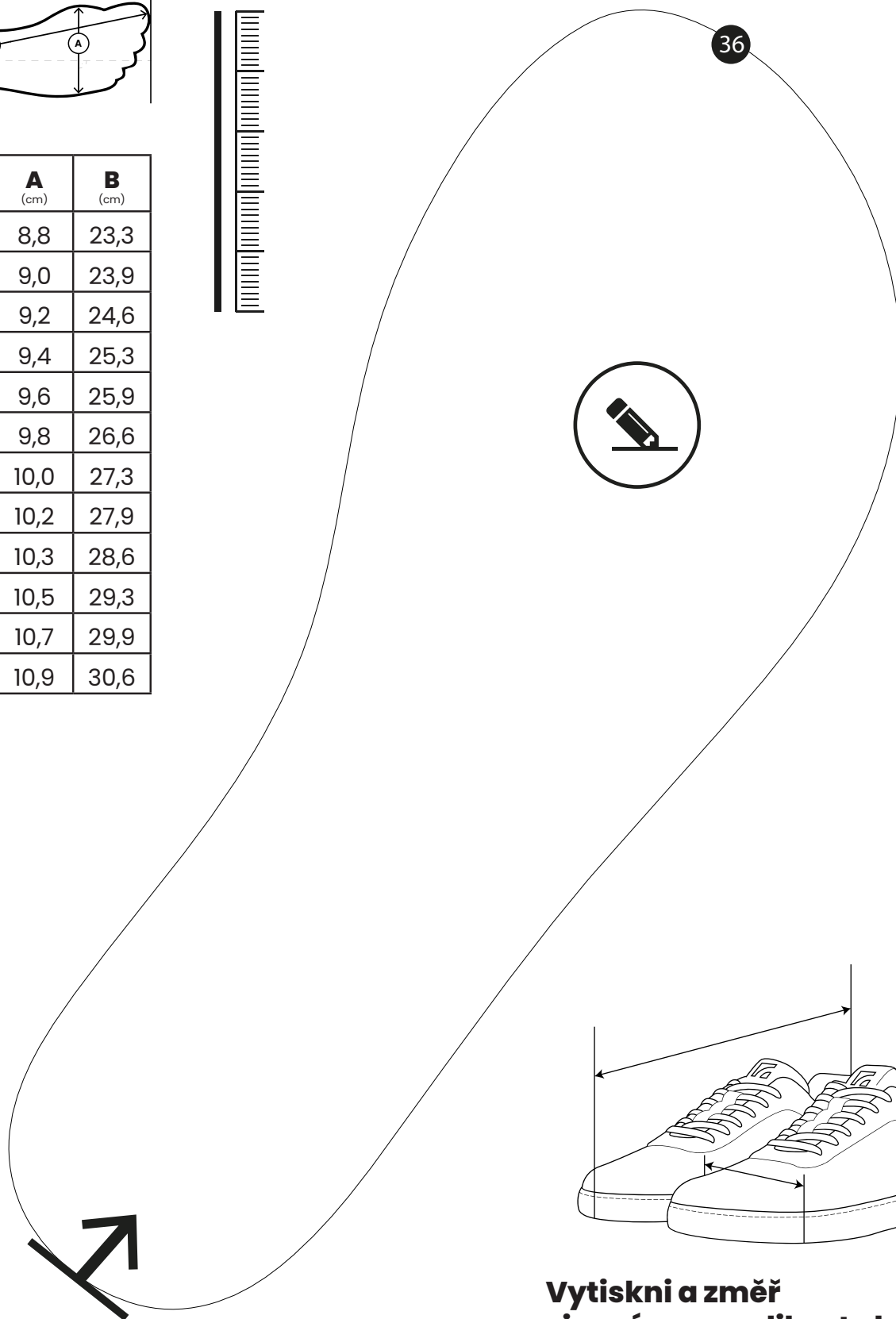

Vytiskni a změř si správnou velikost chodidla.

K celkové délce vašeho chodidla doporučujeme připočítat nadměrok 0,5 - 1,2 cm, čímž získáte ideální velikost boty pro vás.

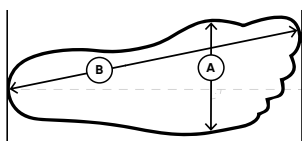

5 cm



EU	A (cm)	B (cm)
36	8,8	23,3
37	9,0	23,9
38	9,2	24,6
39	9,4	25,3
40	9,6	25,9
41	9,8	26,6
42	10,0	27,3
43	10,2	27,9
44	10,3	28,6
45	10,5	29,3
46	10,7	29,9
47	10,9	30,6

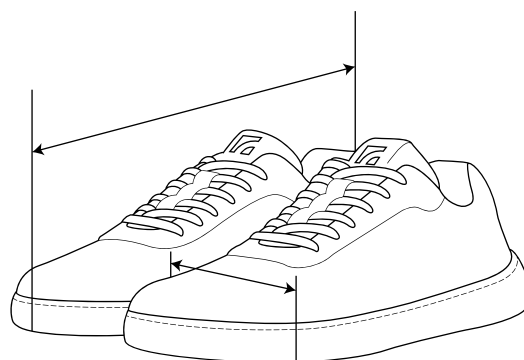
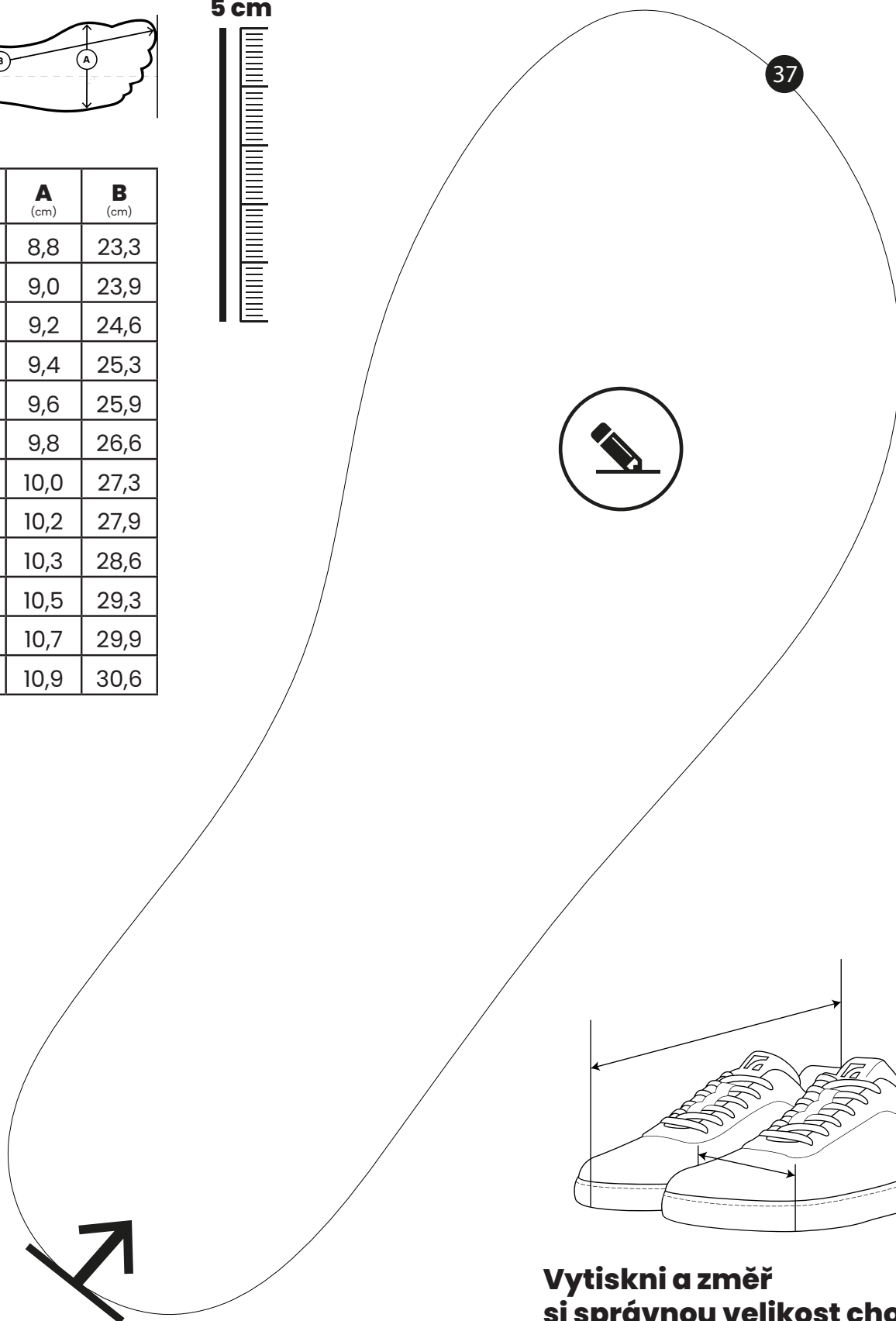

Vytiskni a změř si správnou velikost chodidla.

K celkové délce vašeho chodidla doporučujeme připočítat nadmerok 0,5 - 1,2 cm, čímž získáte ideální velikost boty pro vás.

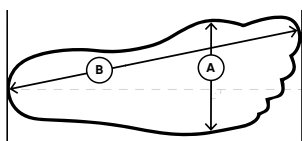

5 cm



EU	A (cm)	B (cm)
36	8,8	23,3
37	9,0	23,9
38	9,2	24,6
39	9,4	25,3
40	9,6	25,9
41	9,8	26,6
42	10,0	27,3
43	10,2	27,9
44	10,3	28,6
45	10,5	29,3
46	10,7	29,9
47	10,9	30,6

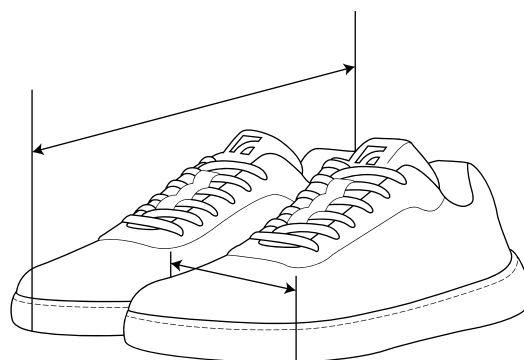
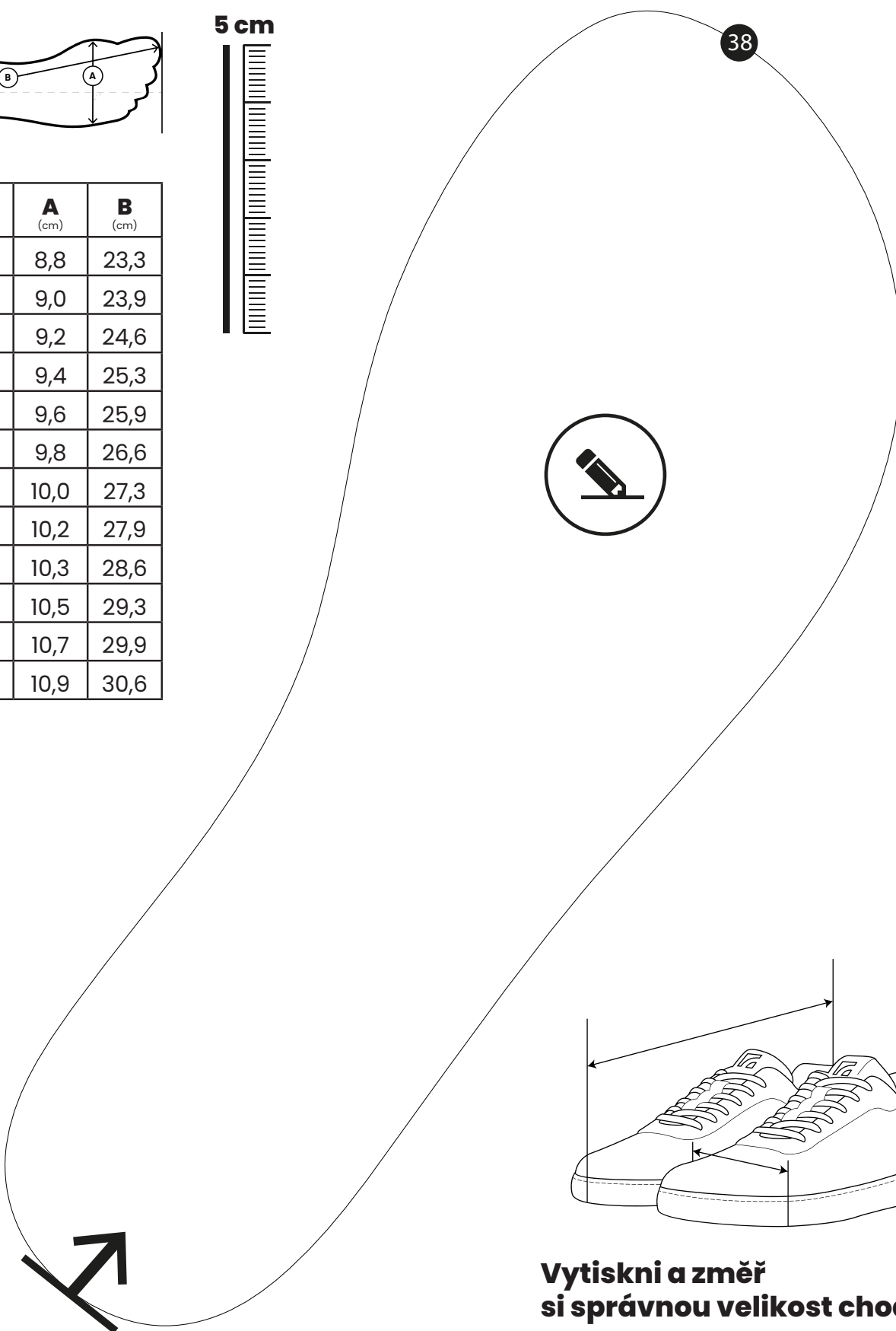

Vytiskni a změř si správnou velikost chodidla.

K celkové délce vašeho chodidla doporučujeme připočítat nadměrok 0,5 - 1,2 cm, čímž získáte ideální velikost boty pro vás.

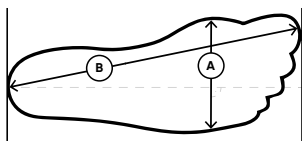

5 cm



EU	A (cm)	B (cm)
36	8,8	23,3
37	9,0	23,9
38	9,2	24,6
39	9,4	25,3
40	9,6	25,9
41	9,8	26,6
42	10,0	27,3
43	10,2	27,9
44	10,3	28,6
45	10,5	29,3
46	10,7	29,9
47	10,9	30,6

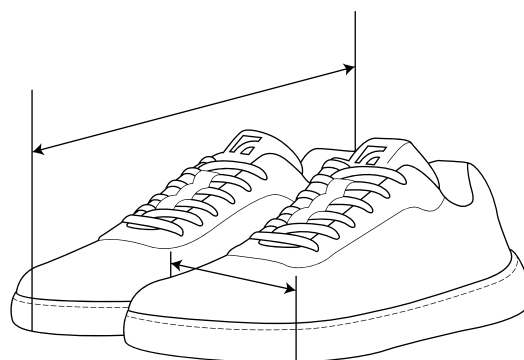
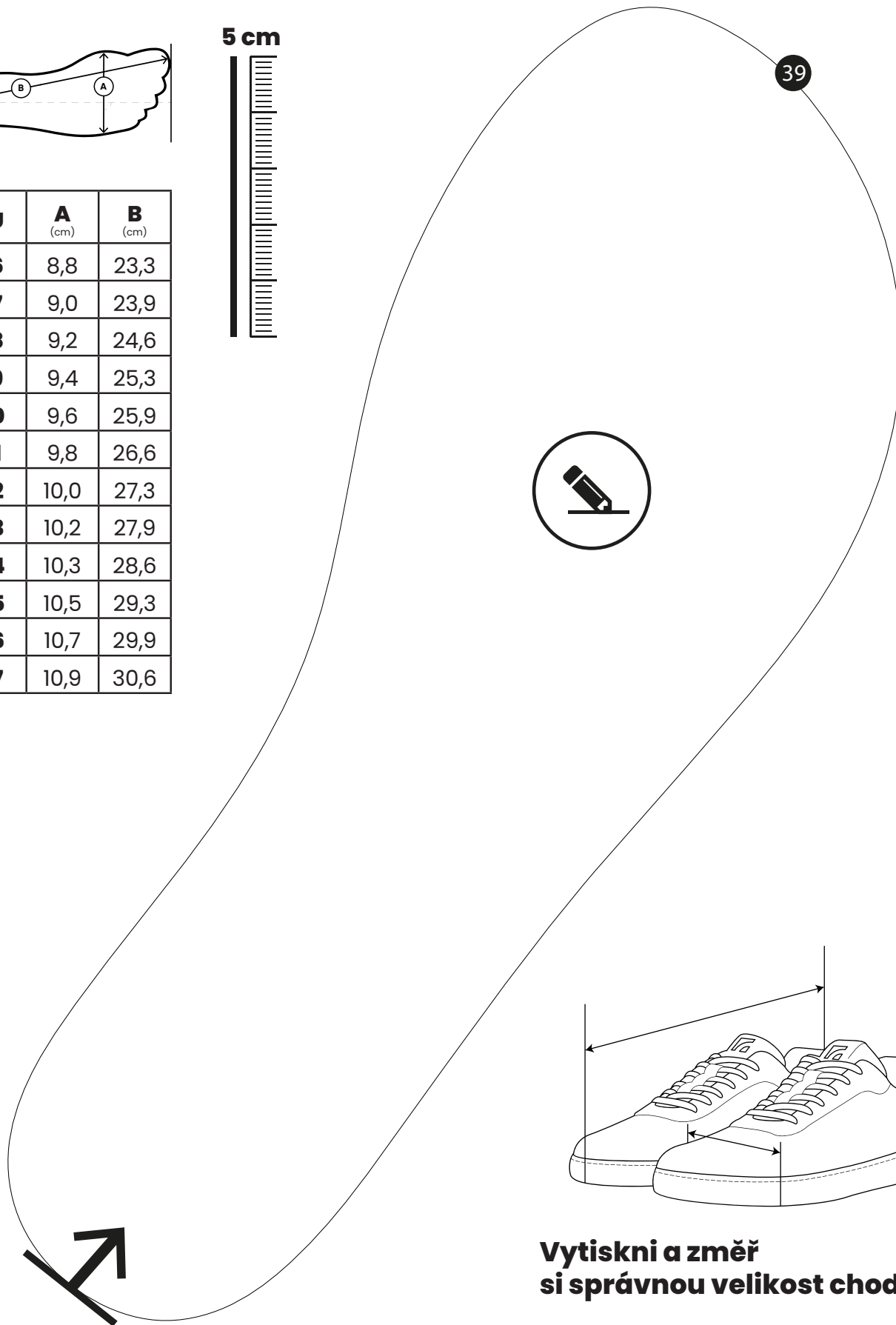

Vytiskni a změř si správnou velikost chodidla.

K celkové délce vašeho chodidla doporučujeme připočítat nadměrok 0,5 - 1,2 cm, čímž získáte ideální velikost boty pro vás.

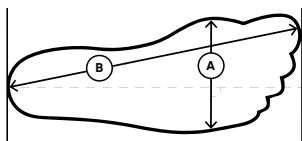

5 cm



EU	A (cm)	B (cm)
36	8,8	23,3
37	9,0	23,9
38	9,2	24,6
39	9,4	25,3
40	9,6	25,9
41	9,8	26,6
42	10,0	27,3
43	10,2	27,9
44	10,3	28,6
45	10,5	29,3
46	10,7	29,9
47	10,9	30,6

40

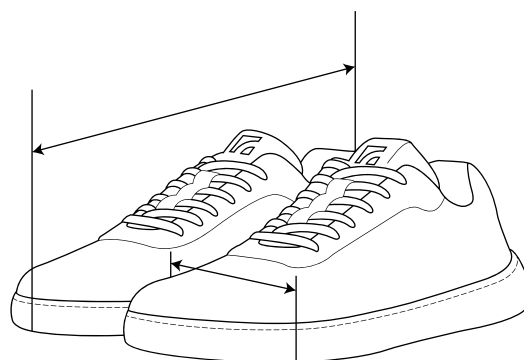

Vytiskni a změř si správnou velikost chodidla.

K celkové délce vašeho chodidla doporučujeme připočítat nadměrok 0,5 - 1,2 cm, čímž získáte ideální velikost boty pro vás.

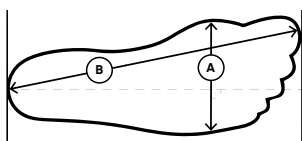

5 cm



EU	A (cm)	B (cm)
36	8,8	23,3
37	9,0	23,9
38	9,2	24,6
39	9,4	25,3
40	9,6	25,9
41	9,8	26,6
42	10,0	27,3
43	10,2	27,9
44	10,3	28,6
45	10,5	29,3
46	10,7	29,9
47	10,9	30,6



41

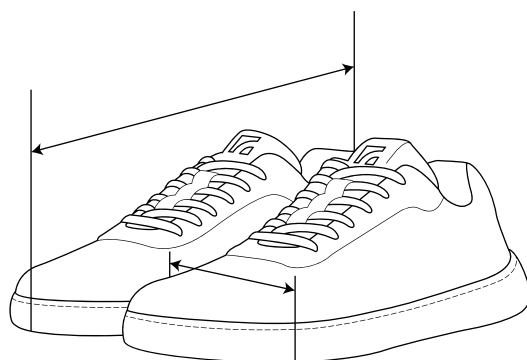

Vytiskni a změř si správnou velikost chodidla.

K celkové délce vašeho chodidla doporučujeme připočítat nadměrok 0,5 - 1,2 cm, čímž získáte ideální velikost boty pro vás.

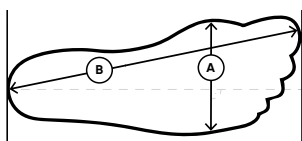

5 cm



EU	A (cm)	B (cm)
36	8,8	23,3
37	9,0	23,9
38	9,2	24,6
39	9,4	25,3
40	9,6	25,9
41	9,8	26,6
42	10,0	27,3
43	10,2	27,9
44	10,3	28,6
45	10,5	29,3
46	10,7	29,9
47	10,9	30,6

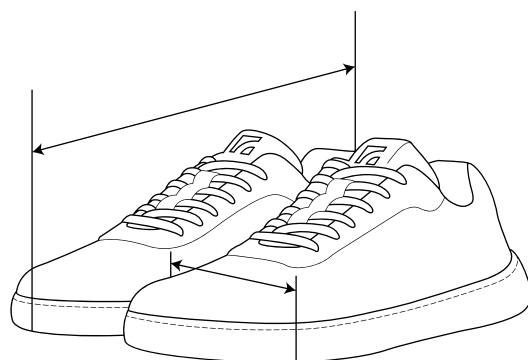

Vytiskni a změř si správnou velikost chodidla.

K celkové délce vašeho chodidla doporučujeme připočítat nadměrok 0,5 - 1,2 cm, čímž získáte ideální velikost boty pro vás.

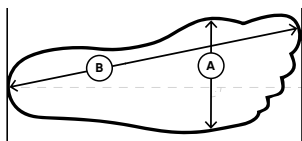

5 cm



EU	A (cm)	B (cm)
36	8,8	23,3
37	9,0	23,9
38	9,2	24,6
39	9,4	25,3
40	9,6	25,9
41	9,8	26,6
42	10,0	27,3
43	10,2	27,9
44	10,3	28,6
45	10,5	29,3
46	10,7	29,9
47	10,9	30,6



43

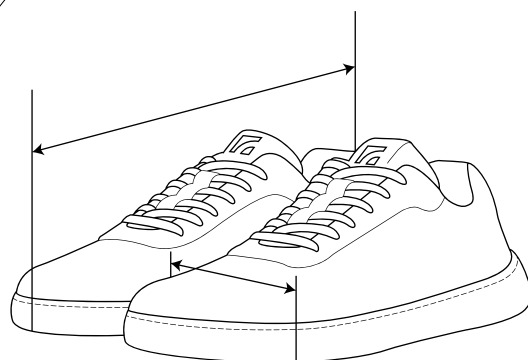

Vytiskni a změř si správnou velikost chodidla.

K celkové délce vašeho chodidla doporučujeme připočítat nadměrok 0,5 - 1,2 cm, čímž získáte ideální velikost boty pro vás.

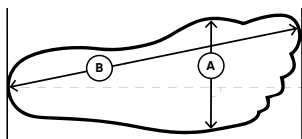

5 cm



EU	A (cm)	B (cm)
36	8,8	23,3
37	9,0	23,9
38	9,2	24,6
39	9,4	25,3
40	9,6	25,9
41	9,8	26,6
42	10,0	27,3
43	10,2	27,9
44	10,3	28,6
45	10,5	29,3
46	10,7	29,9
47	10,9	30,6

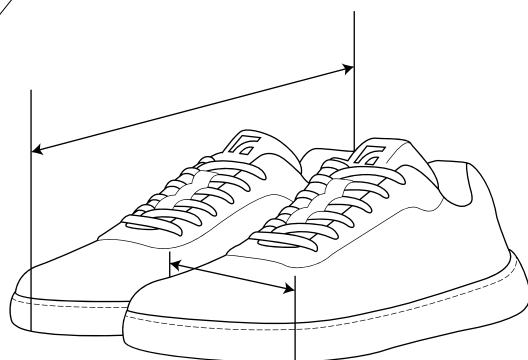

Vytiskni a změř si správnou velikost chodidla.

K celkové délce vašeho chodidla doporučujeme připočítat nadměrok 0,5 - 1,2 cm, čímž získáte ideální velikost boty pro vás.

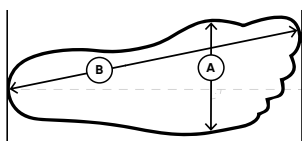

**5 cm**

EU	A (cm)	B (cm)
36	8,8	23,3
37	9,0	23,9
38	9,2	24,6
39	9,4	25,3
40	9,6	25,9
41	9,8	26,6
42	10,0	27,3
43	10,2	27,9
44	10,3	28,6
45	10,5	29,3
46	10,7	29,9
47	10,9	30,6



45

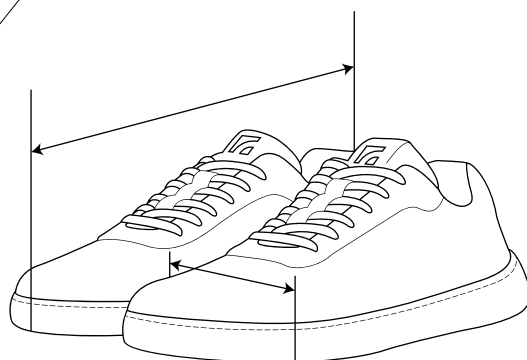

Vytiskni a změř si správnou velikost chodidla.

K celkové délce vašeho chodidla doporučujeme připočítat nadměrok 0,5 - 1,2 cm, čímž získáte ideální velikost boty pro vás.



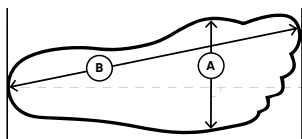

5 cm



EU	A (cm)	B (cm)
36	8,8	23,3
37	9,0	23,9
38	9,2	24,6
39	9,4	25,3
40	9,6	25,9
41	9,8	26,6
42	10,0	27,3
43	10,2	27,9
44	10,3	28,6
45	10,5	29,3
46	10,7	29,9
47	10,9	30,6

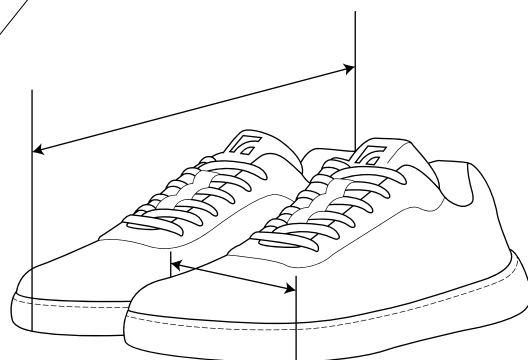

Vytiskni a změř si správnou velikost chodidla.

K celkové délce vašeho chodidla doporučujeme připočítat nadměrok 0,5 - 1,2 cm, čímž získáte ideální velikost boty pro vás.



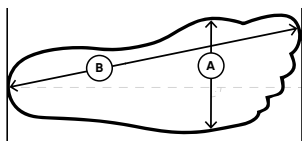

5 cm



EU	A (cm)	B (cm)
36	8,8	23,3
37	9,0	23,9
38	9,2	24,6
39	9,4	25,3
40	9,6	25,9
41	9,8	26,6
42	10,0	27,3
43	10,2	27,9
44	10,3	28,6
45	10,5	29,3
46	10,7	29,9
47	10,9	30,6

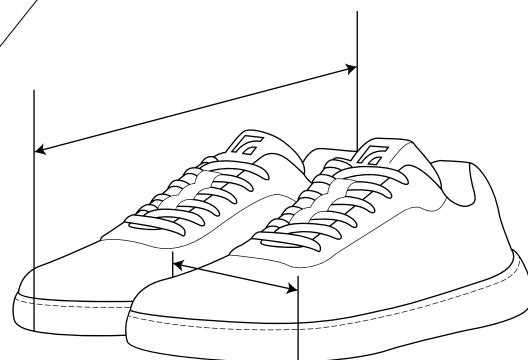

Vytiskni a změř si správnou velikost chodidla.

K celkové délce vašeho chodidla doporučujeme připočítat nadměrok 0,5 - 1,2 cm, čímž získáte ideální velikost boty pro vás.

